



16-BIT, ULTRA-LOW GLITCH, VOLTAGE OUTPUT DIGITAL-TO-ANALOG CONVERTER

Check for Samples: [DAC8550](#)

FEATURES

- **Relative Accuracy: 3LSB**
- **Glitch Energy: 0.1nV-s**
- **MicroPower Operation:**
140 μ A at 2.7V
- **Power-On Reset to Midscale**
- **Power Supply: +2.7V to +5.5V**
- **16-Bit Monotonic Over Temperature**
- **Settling Time: 10 μ s to \pm 0.003% FSR**
- **Low-Power Serial Interface with Schmitt-Triggered Inputs**
- **On-Chip Output Buffer Amplifier with Rail-to-Rail Output Amplifier**
- **Power-Down Capability**
- **2's Complement Input**
- **$\overline{\text{SYNC}}$ Interrupt Facility**
- **Drop-In Compatible with DAC8531/01 and DAC8551 (Binary Input)**
- **Available in a Tiny MSOP-8 Package**

APPLICATIONS

- **Process Control**
- **Data Acquisition Systems**
- **Closed-Loop Servo-Control**
- **PC Peripherals**
- **Portable Instrumentation**
- **Programmable Attenuation**

DESCRIPTION

The DAC8550 is a small, low-power, voltage output, 16-bit digital-to-analog converter (DAC). It is monotonic, provides good linearity, and minimizes undesired code-to-code transient voltages. The DAC8550 uses a versatile, 3-wire serial interface that operates at clock rates of up to 30MHz and is compatible with standard SPI™, QSPI™, Microwire™, and digital signal processor (DSP) interfaces.

The DAC8550 requires an external reference voltage to set its output range. The DAC8550 incorporates a power-on reset circuit that ensures that the DAC output powers up at midscale and remains there until a valid write takes place to the device. The DAC8550 contains a power-down feature, accessed over the serial interface, that reduces the current consumption of the device to 200nA at 5V.

The low-power consumption of this device in normal operation makes it ideal for portable, battery-operated equipment. Power consumption is 0.38mW at 2.7V, reducing to less than 1 μ W in power-down mode.

The DAC8550 is available in an MSOP-8 package.

For additional flexibility, see the DAC8551, a binary-coded counterpart to the DAC8550.

FUNCTIONAL BLOCK DIAGRAM

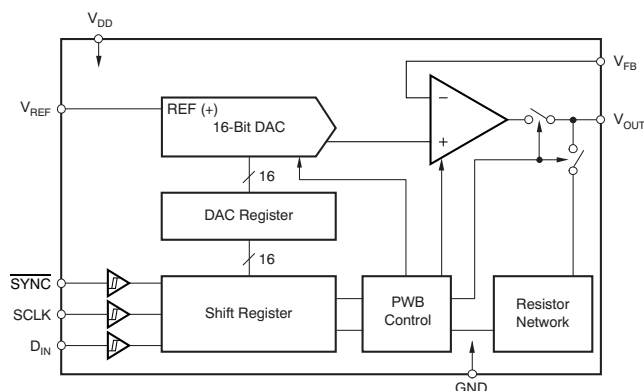

Please be aware that an important notice concerning availability, standard warranty, and use in critical applications of Texas Instruments semiconductor products and disclaimers thereto appears at the end of this data sheet.

SPI, QSPI are trademarks of Motorola, Inc.

Microwire is a trademark of National Semiconductor.

All other trademarks are the property of their respective owners.



This integrated circuit can be damaged by ESD. Texas Instruments recommends that all integrated circuits be handled with appropriate precautions. Failure to observe proper handling and installation procedures can cause damage.

ESD damage can range from subtle performance degradation to complete device failure. Precision integrated circuits may be more susceptible to damage because very small parametric changes could cause the device not to meet its published specifications.

PACKAGING/ORDERING INFORMATION

PRODUCT	MAXIMUM RELATIVE ACCURACY (LSB)	MAXIMUM DIFFERENTIAL NONLINEARITY (LSB)	PACKAGE LEAD	PACKAGE DESIGNATOR ⁽¹⁾	SPECIFIED TEMPERATURE RANGE	PACKAGE MARKING	ORDERING NUMBER	TRANSPORT MEDIA, QUANTITY
DAC8550	±12	±1	MSOP-8	DGK	–40°C to +105°C	D80	DAC8550IDGKT	Tape and Reel, 250
							DAC8550IDGKR	Tape and Reel, 2500
DAC8550B	±8	±1	MSOP-8	DGK	–40°C to +105°C	D80	DAC8550IBDGKT	Tape and Reel, 250
							DAC8550IBDGKR	Tape and Reel, 2500

(1) For the most current package and ordering information see the Package Option Addendum at the end of this document, or see the TI website at www.ti.com.

ABSOLUTE MAXIMUM RATINGS⁽¹⁾

	UNIT
Supply voltage, V _{DD} to GND	–0.3V to 6V
Digital input voltage range, V _I to GND	–0.3V to +V _{DD} + 0.3V
Output voltage, V _{OUT} to GND	–0.3V to +V _{DD} + 0.3V
Operating free-air temperature range, T _A	–40°C to +105°C
Storage temperature range, T _{STG}	–65°C to +150°C
Junction temperature range, T _{J (max)}	150°C
Power dissipation (DGK package)	(T _{Jmax} – T _A)/θ _{JA}
Thermal impedance, θ _{JA}	206°C/W
Thermal impedance, θ _{JC}	44°C/W

(1) Stresses above those listed under *absolute maximum ratings* may cause permanent damage to the device. Exposure to absolute maximum conditions for extended periods may affect device reliability.

ELECTRICAL CHARACTERISTICS

V_{DD} = 2.7V to 5.5V, –40°C to +105°C range (unless otherwise noted).

PARAMETER		TEST CONDITIONS	MIN	TYP	MAX	UNIT
STATIC PERFORMANCE⁽¹⁾						
	Resolution		16			Bits
E _L	Relative accuracy	Measured by line passing through codes –32283 and +32063	DAC8550	±3	±12	LSB
			DAC8550B	±3	±8	LSB
E _D	Differential nonlinearity	16-bit Monotonic		±0.25	±1	LSB
E _O	Zero-code error	Measured by line passing through codes –32283 and +32063.		±2	±12	mV
E _{FS}	Full-scale error			±0.05	±0.5	% of FSR
E _G	Gain error			±0.02	±0.2	% of FSR
	Zero-code error drift				±5	µV/°C
	Gain temperature coefficient			±1		ppm of FSR/°C
PSRR	Power-supply rejection ratio	R _L = 2kΩ, C _L = 200pF		0.75		mV/V

(1) Linearity calculated using a reduced code range of –32283 to +32063; output unloaded.

ELECTRICAL CHARACTERISTICS (continued)
 $V_{DD} = 2.7V$ to $5.5V$, $-40^{\circ}C$ to $+105^{\circ}C$ range (unless otherwise noted).

PARAMETER	TEST CONDITIONS	MIN	TYP	MAX	UNIT	
OUTPUT CHARACTERISTICS⁽²⁾						
V_O	Output voltage range	0		V_{REF}	V	
t_{SD}	Output voltage settling time	To $\pm 0.003\%$ FSR, 1200h to 8D00h, $R_L = 2k\Omega$, $0pF < C_L < 200pF$		8	10	μs
		$R_L = 2k\Omega$, $C_L = 500pF$		12		μs
SR	Slew rate		1.8		V/ μs	
	Capacitive load stability	$R_L = \infty$		470		pF
		$R_L = 2k\Omega$		1000		pF
	Code change glitch impulse	1LSB change around major carry		0.1	nV-s	
	Digital feedthrough	SCLK toggling, FSYNC high		0.1		
z_O	DC output impedance	At mid-code input		1	Ω	
I_{OS}	Short-circuit current	$V_{DD} = 5V$		50	mA	
		$V_{DD} = 3V$		20		
t_{ON}	Power-up time	Coming out of power-down mode, $V_{DD} = 5V$		2.5	μs	
		Coming out of power-down mode, $V_{DD} = 3V$		5		
AC PERFORMANCE						
SNR	Signal-to-noise ratio	BW = 20kHz, $V_{DD} = 5V$, $f_{OUT} = 1kHz$, 1st 19 harmonics removed for SNR calculation		95	dB	
THD	Total harmonic distortion			-85		
SFDR	Spurious-free dynamic range			87		
SINAD	Signal-to-noise and distortion			84		
REFERENCE INPUT						
V_{REF}	Reference voltage	0		V_{DD}	V	
$I_{I(REF)}$	Reference current input range	$V_{REF} = V_{DD} = 5V$		40	75	μA
		$V_{REF} = V_{DD} = 3.6V$		30	45	μA
$Z_{I(REF)}$	Reference input impedance			125	k Ω	
LOGIC INPUTS⁽³⁾						
Input current				± 1	μA	
V_{IL}	Low-level input voltage	$V_{DD} = 5V$		$0.3V_{DD}$		V
		$V_{DD} = 3V$		$0.1V_{DD}$		
V_{IH}	High-level input voltage	$V_{DD} = 5V$		$0.7V_{DD}$		V
		$V_{DD} = 3V$		$0.9V_{DD}$		
Pin capacitance				3	pF	
POWER REQUIREMENTS						
V_{DD}		2.7		5.5	V	
I_{DD} (normal mode)	Input code equals mid-scale, no load, does not include reference current					
	$V_{DD} = 3.6V$ to $5.5V$ $V_{DD} = 2.7V$ to $3.6V$	$V_{IH} = V_{DD}$ and $V_{IL} = GND$		160	250	μA
				140	240	
I_{DD} (all power-down modes)	$V_{DD} = 3.6V$ to $5.5V$ $V_{DD} = 2.7V$ to $3.6V$	$V_{IH} = V_{DD}$ and $V_{IL} = GND$		0.2	2	μA
				0.05	2	
POWER EFFICIENCY						
I_{OUT}/I_{DD}	$I_{LOAD} = 2mA$, $V_{DD} = 5V$			89	%	
TEMPERATURE RANGE						
Specified performance		-40		+105	$^{\circ}C$	

(2) Specified by design and characterization, not production tested.

(3) Specified by design and characterization, not production tested.

PIN CONFIGURATION

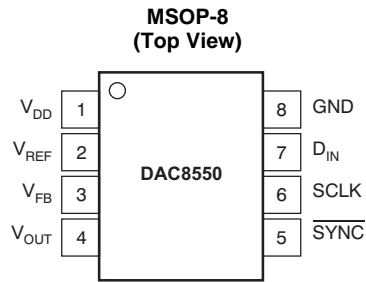

PIN DESCRIPTIONS

PIN	NAME	DESCRIPTION
1	V_{DD}	Power-supply input, 2.7V to 5.5V.
2	V_{REF}	Reference voltage input.
3	V_{FB}	Feedback connection for the output amplifier.
4	V_{OUT}	Analog output voltage from DAC. The output amplifier has rail-to-rail operation.
5	\overline{SYNC}	Level-triggered control input (active LOW). This is the frame synchronization signal for the input data. When \overline{SYNC} goes LOW, it enables the input shift register and data is transferred in on the falling edges of the following clocks. The DAC is updated following the 24th clock (unless \overline{SYNC} is taken HIGH before this edge, in which case the rising edge of \overline{SYNC} acts as an interrupt and the write sequence is ignored by the DAC8550). Schmitt-Trigger logic input.
6	SCLK	Serial clock input. Data can be transferred at rates up to 30MHz. Schmitt-Trigger logic input.
7	D_{IN}	Serial data input. Data is clocked into the 24-bit input shift register on each falling edge of the serial clock input. Schmitt-Trigger logic input.
8	GND	Ground reference point for all circuitry on the part.

SERIAL WRITE OPERATION

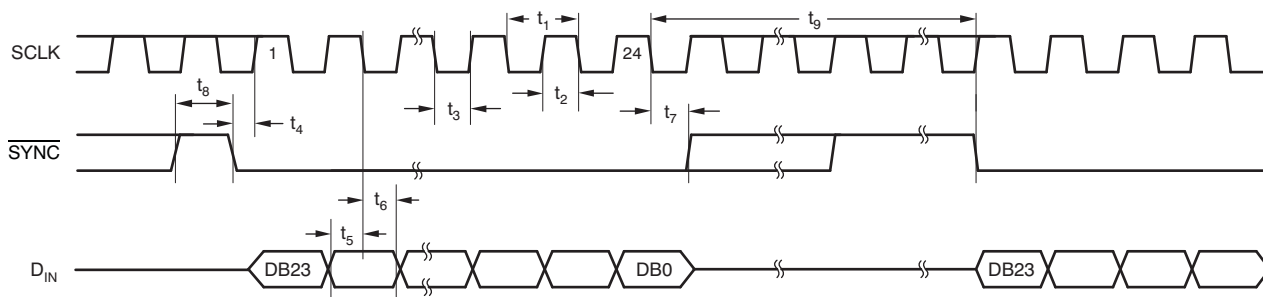

TIMING CHARACTERISTICS^{(1) (2)}

$V_{DD} = 2.7V$ to $5.5V$, all specifications $-40^{\circ}C$ to $+105^{\circ}C$ (unless otherwise noted).

PARAMETER		TEST CONDITIONS	MIN	TYP	MAX	UNIT
t ₁ ⁽³⁾	SCLK cycle time	$V_{DD} = 2.7V$ to $3.6V$	50			ns
		$V_{DD} = 3.6V$ to $5.5V$	33			
t ₂	SCLK HIGH time	$V_{DD} = 2.7V$ to $3.6V$	13			ns
		$V_{DD} = 3.6V$ to $5.5V$	13			
t ₃	SCLK LOW time	$V_{DD} = 2.7V$ to $3.6V$	22.5			ns
		$V_{DD} = 3.6V$ to $5.5V$	13			
t ₄	\overline{SYNC} to SCLK rising edge setup time	$V_{DD} = 2.7V$ to $3.6V$	0			ns
		$V_{DD} = 3.6V$ to $5.5V$	0			
t ₅	Data setup time	$V_{DD} = 2.7V$ to $3.6V$	5			ns
		$V_{DD} = 3.6V$ to $5.5V$	5			
t ₆	Data hold time	$V_{DD} = 2.7V$ to $3.6V$	4.5			ns
		$V_{DD} = 3.6V$ to $5.5V$	4.5			
t ₇	24th SCLK falling edge to \overline{SYNC} rising edge	$V_{DD} = 2.7V$ to $3.6V$	0			ns
		$V_{DD} = 3.6V$ to $5.5V$	0			
t ₈	Minimum \overline{SYNC} HIGH time	$V_{DD} = 2.7V$ to $3.6V$	50			ns
		$V_{DD} = 3.6V$ to $5.5V$	33			
t ₉	24th SCLK falling edge to \overline{SYNC} falling edge	$V_{DD} = 2.7V$ to $5.5V$	100			ns

(1) All input signals are specified with $t_R = t_F = 5ns$ (10% to 90% of V_{DD}) and timed from a voltage level of $(V_{IL} + V_{IH})/2$.

(2) See [Serial Write Operation Timing Diagram](#).

(3) Maximum SCLK frequency is 30MHz at $V_{DD} = 3.6V$ to $5.5V$ and 20MHz at $V_{DD} = 2.7V$ to $3.6V$.

TYPICAL CHARACTERISTICS: $V_{DD} = 5\text{ V}$

At $T_A = +25^\circ\text{C}$, unless otherwise noted.

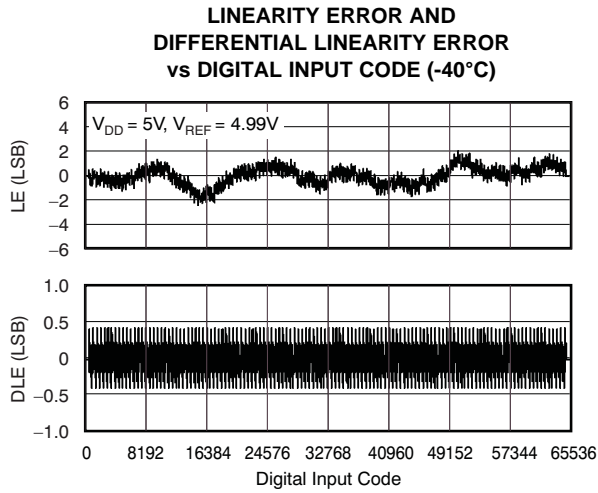

Figure 1.

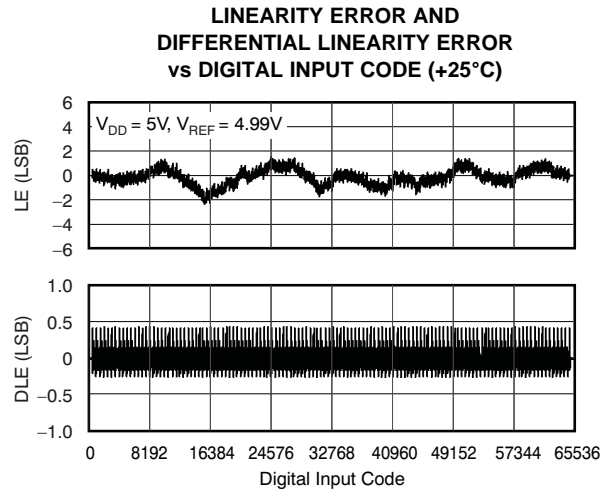

Figure 2.

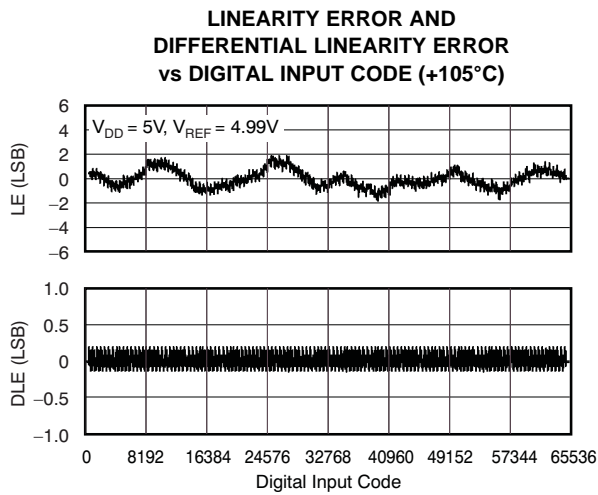

Figure 3.

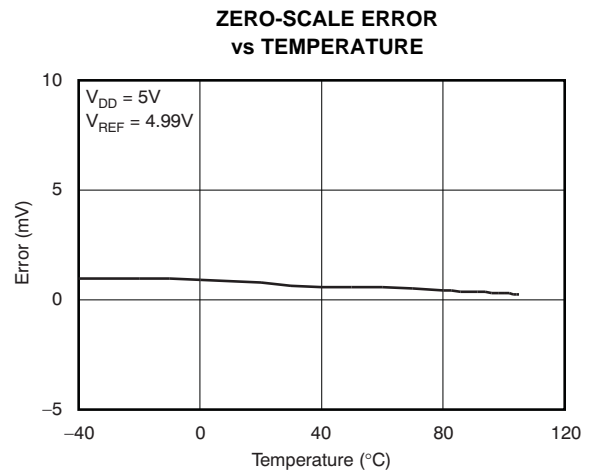

Figure 4.

TYPICAL CHARACTERISTICS: $V_{DD} = 5\text{ V}$ (continued)

At $T_A = +25^\circ\text{C}$, unless otherwise noted.

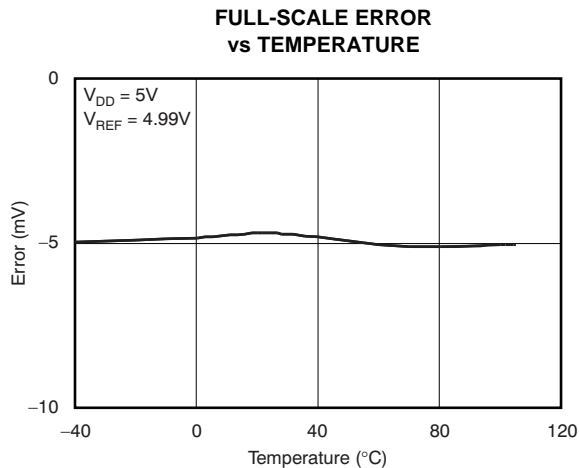

Figure 5.

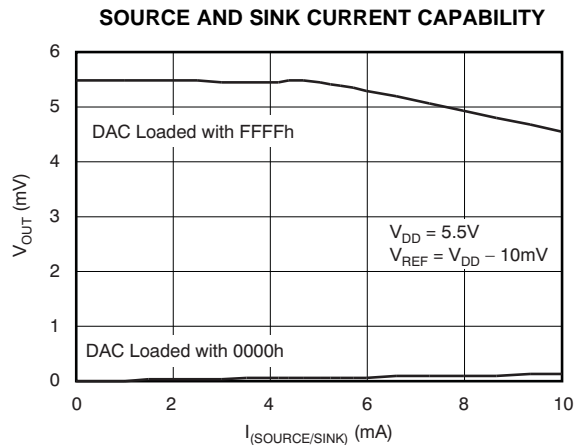

Figure 6.

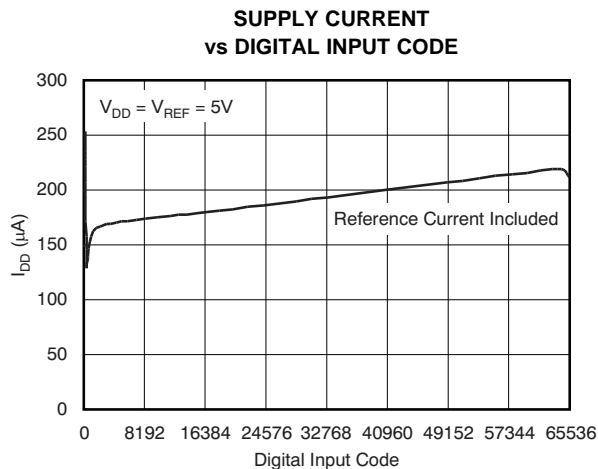

Figure 7.

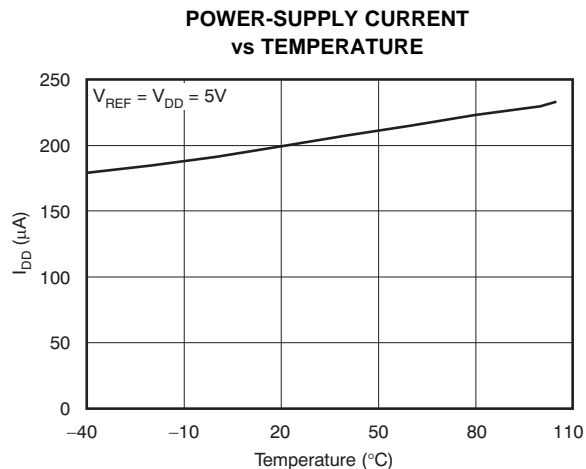

Figure 8.

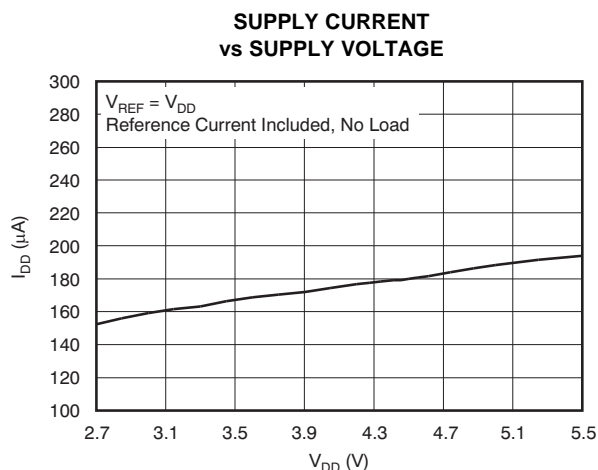

Figure 9.

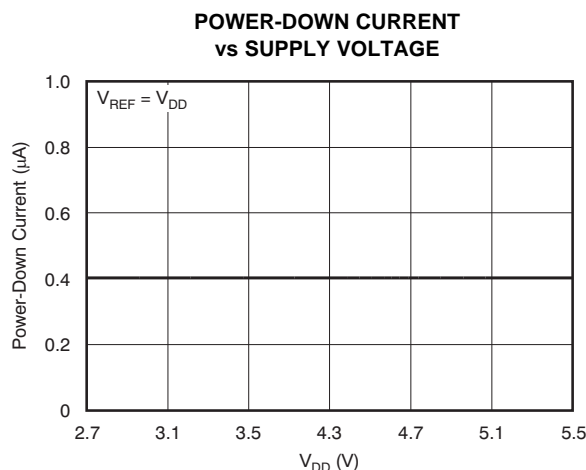

Figure 10.

TYPICAL CHARACTERISTICS: $V_{DD} = 5\text{ V}$ (continued)

At $T_A = +25^\circ\text{C}$, unless otherwise noted.

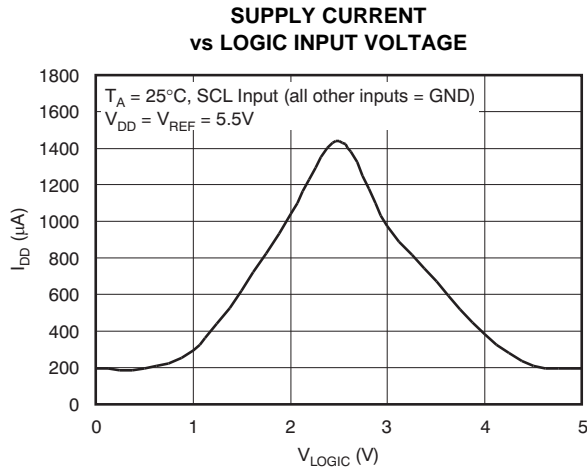

Figure 11.

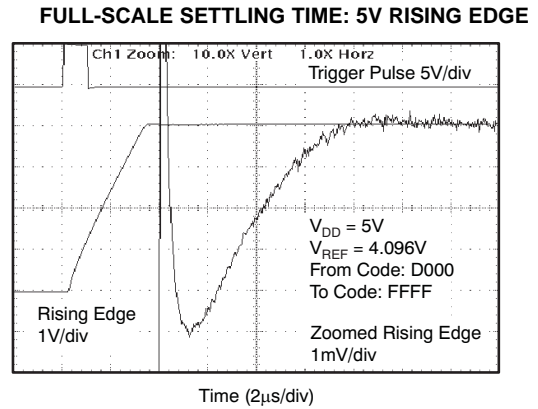

Figure 12.

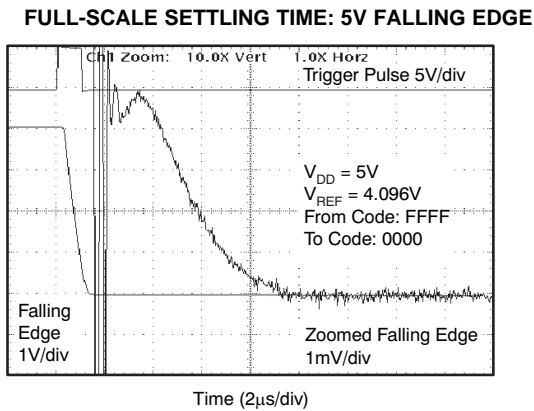

Figure 13.

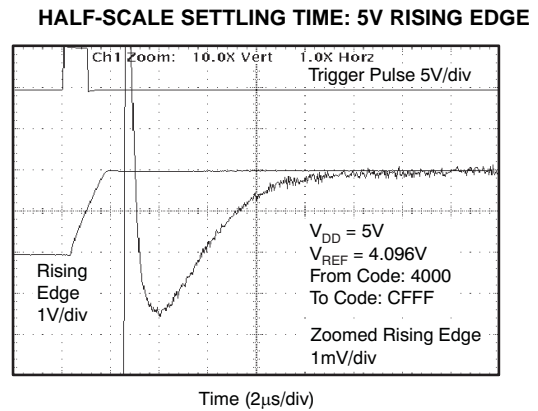

Figure 14.

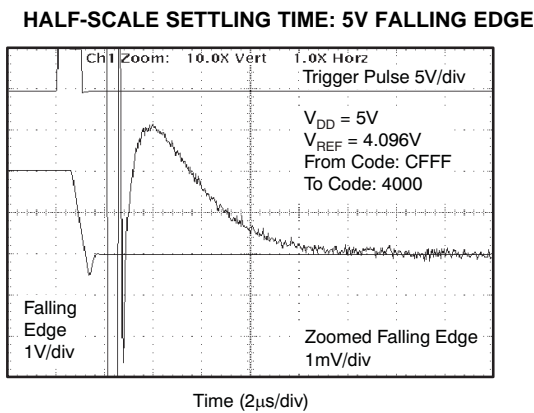

Figure 15.

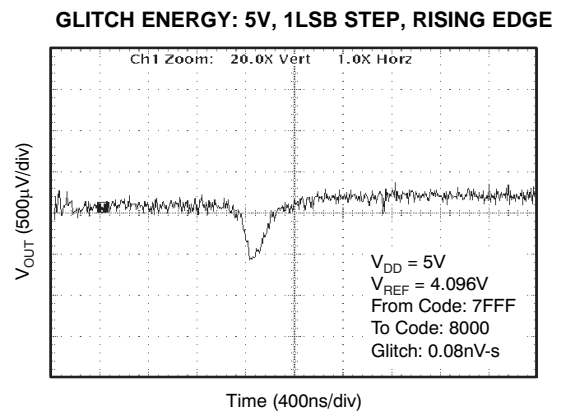

Figure 16.

TYPICAL CHARACTERISTICS: $V_{DD} = 5\text{ V}$ (continued)

At $T_A = +25^\circ\text{C}$, unless otherwise noted.

GLITCH ENERGY: 5V, 1LSB STEP, FALLING EDGE

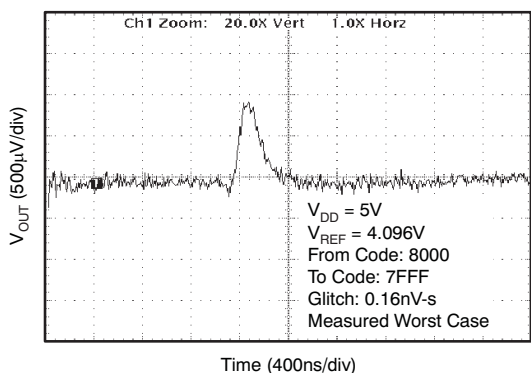

Figure 17.

GLITCH ENERGY: 5V, 16LSB STEP, RISING EDGE

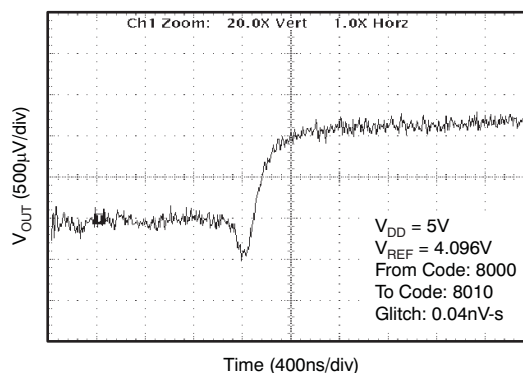

Figure 18.

GLITCH ENERGY: 5V, 16LSB STEP, FALLING EDGE

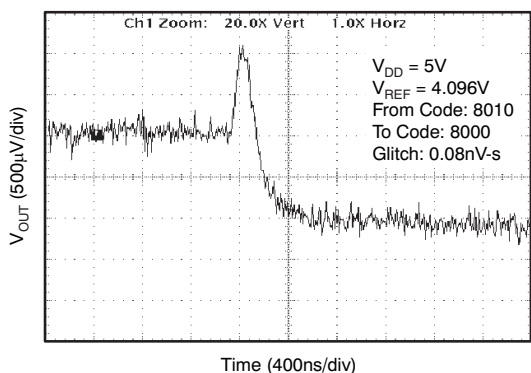

Figure 19.

GLITCH ENERGY: 5V, 256LSB STEP, RISING EDGE

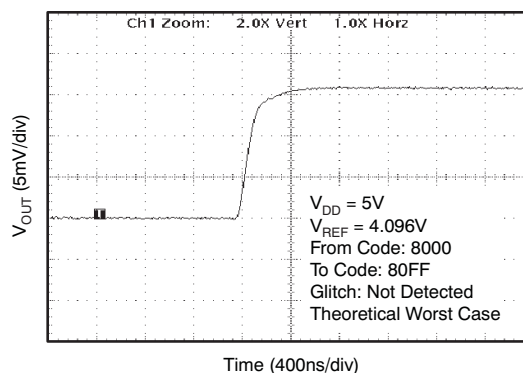

Figure 20.

GLITCH ENERGY: 5V, 256LSB STEP, FALLING EDGE

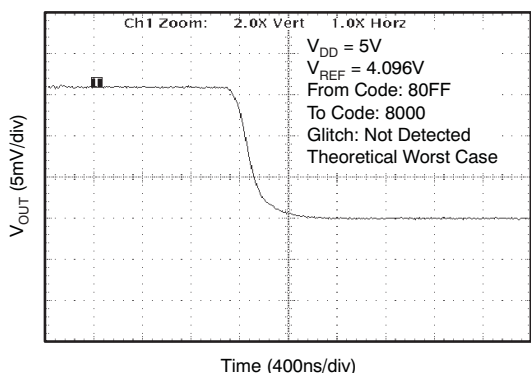

Figure 21.

TOTAL HARMONIC DISTORTION vs OUTPUT FREQUENCY

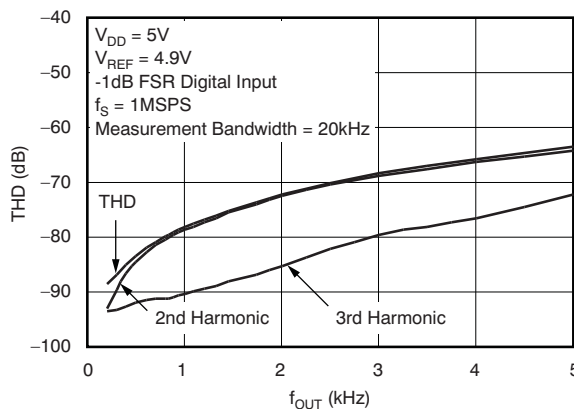

Figure 22.

TYPICAL CHARACTERISTICS: $V_{DD} = 5\text{ V}$ (continued)

At $T_A = +25^\circ\text{C}$, unless otherwise noted.

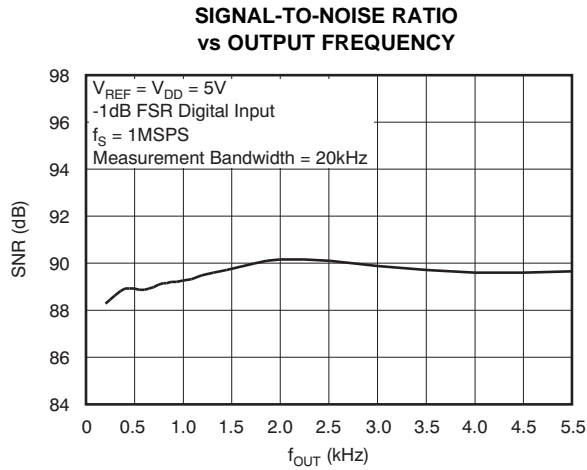

Figure 23.

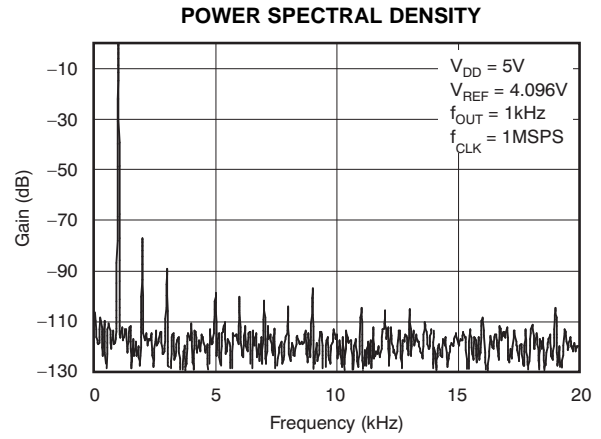

Figure 24.

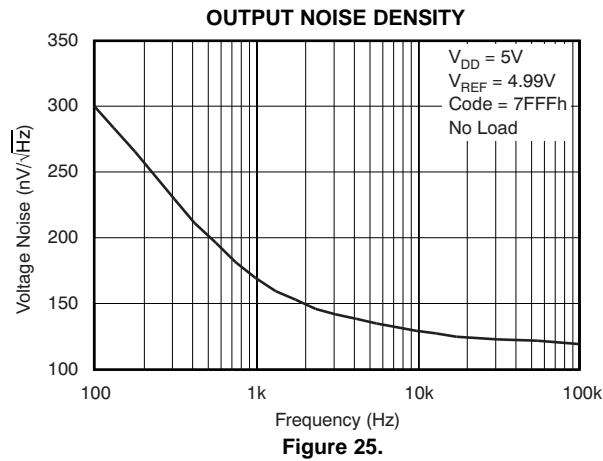

Figure 25.

TYPICAL CHARACTERISTICS: $V_{DD} = 2.7\text{ V}$

At $T_A = +25^\circ\text{C}$, unless otherwise noted.

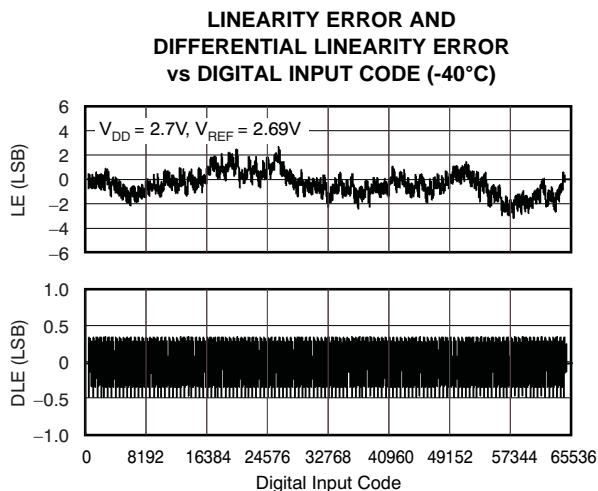

Figure 26.

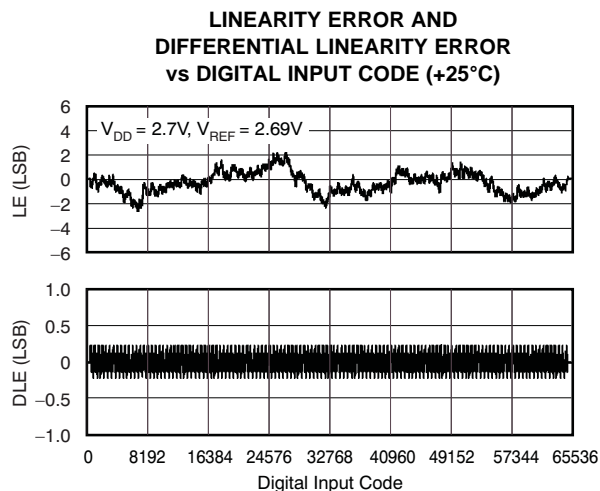

Figure 27.

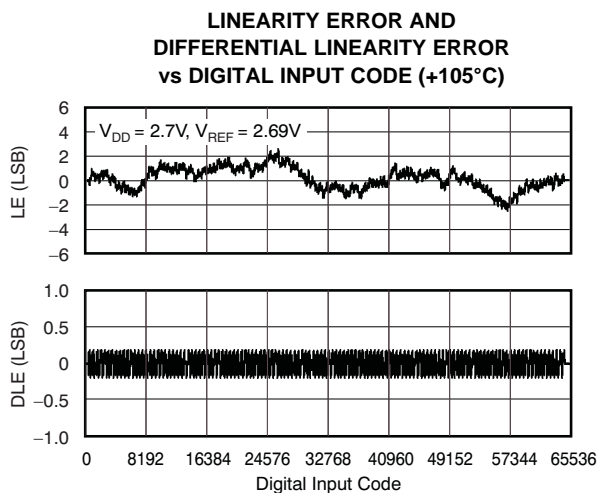

Figure 28.

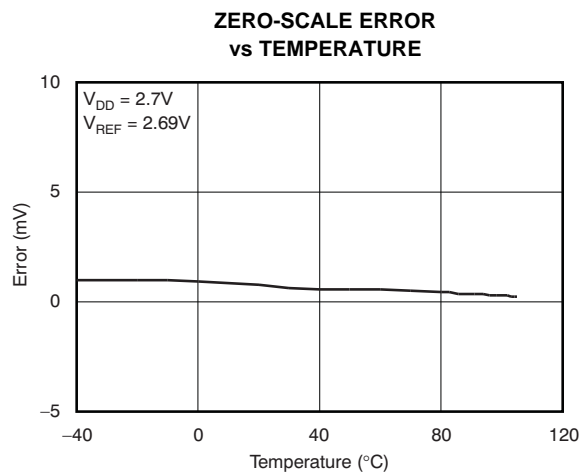

Figure 29.

TYPICAL CHARACTERISTICS: $V_{DD} = 2.7\text{ V}$ (continued)

At $T_A = +25^\circ\text{C}$, unless otherwise noted.

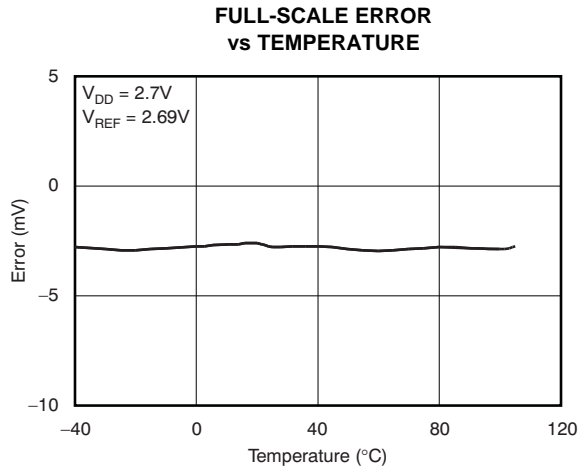

Figure 30.

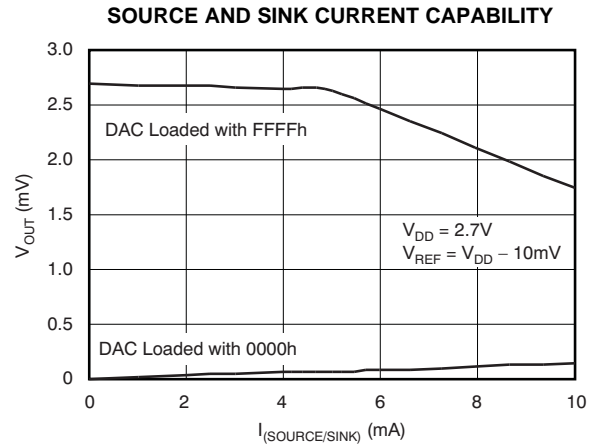

Figure 31.

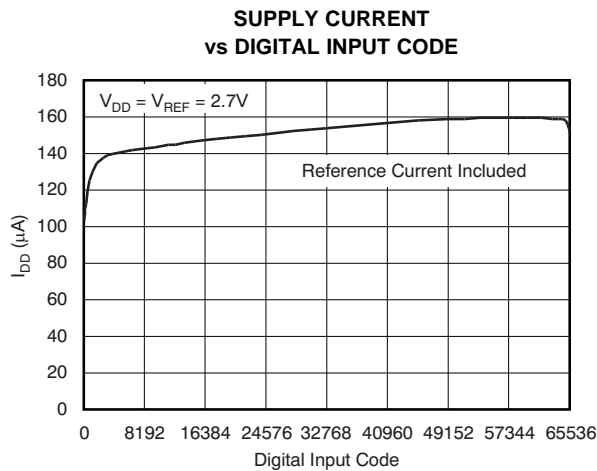

Figure 32.

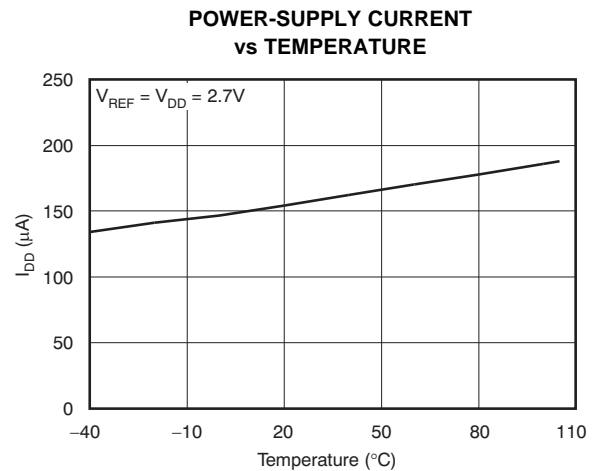

Figure 33.

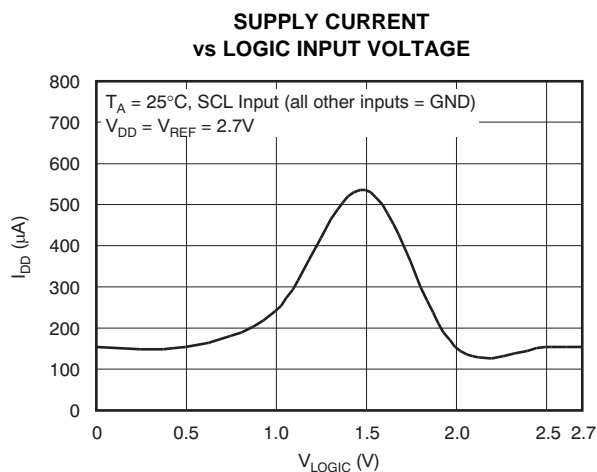

Figure 34.

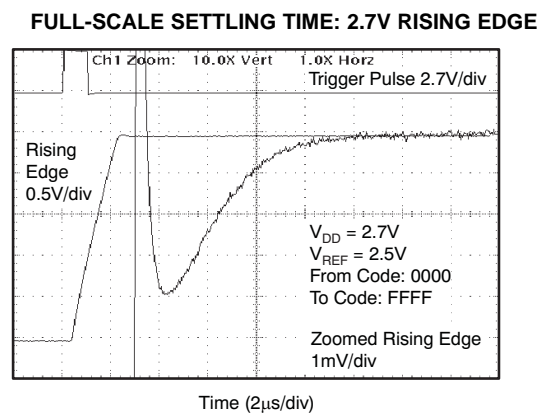
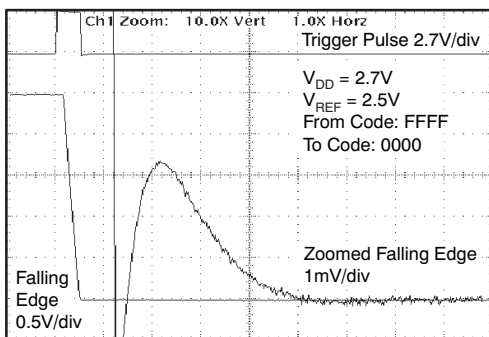

Figure 35.

TYPICAL CHARACTERISTICS: $V_{DD} = 2.7\text{ V}$ (continued)

At $T_A = +25^\circ\text{C}$, unless otherwise noted.

FULL-SCALE SETTLING TIME: 2.7V FALLING EDGE



Time (2µs/div)

Figure 36.

HALF-SCALE SETTLING TIME: 2.7V RISING EDGE

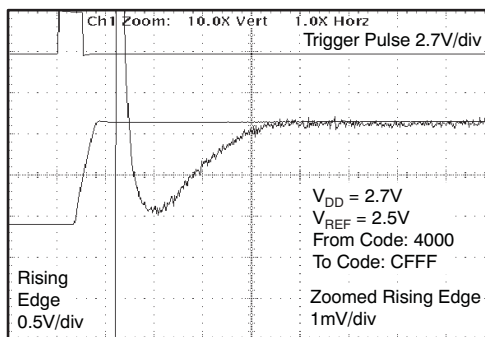

Time (2µs/div)

Figure 37.

HALF-SCALE SETTLING TIME: 2.7V FALLING EDGE

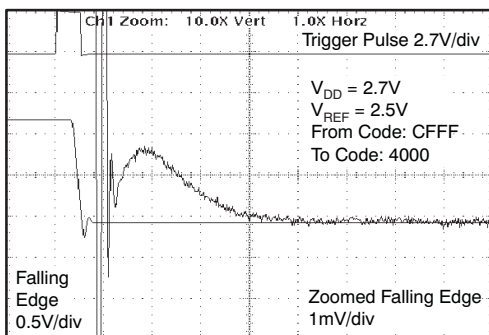

Time (2µs/div)

Figure 38.

GLITCH ENERGY: 2.7V, 1LSB STEP, RISING EDGE

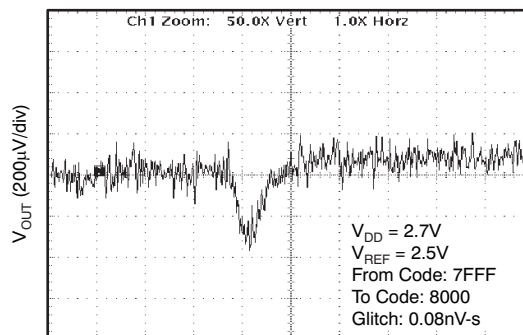

Time (400ns/div)

Figure 39.

GLITCH ENERGY: 2.7V, 1LSB STEP, FALLING EDGE

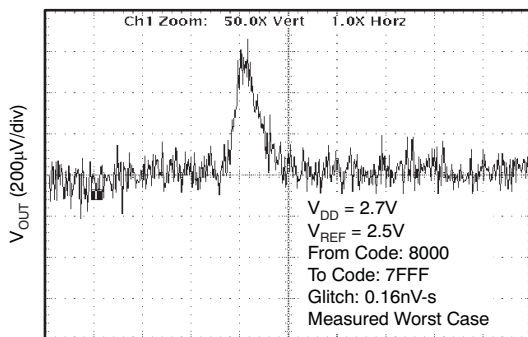

Time (400ns/div)

Figure 40.

GLITCH ENERGY: 2.7V, 16LSB STEP, RISING EDGE

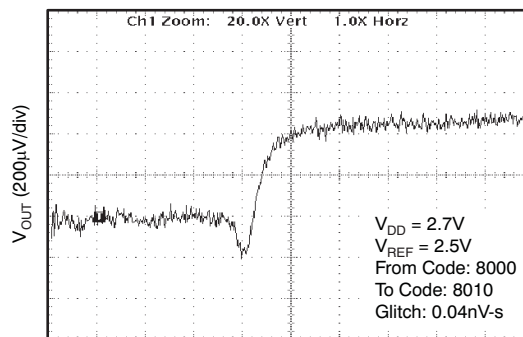

Time (400ns/div)

Figure 41.

TYPICAL CHARACTERISTICS: $V_{DD} = 2.7\text{ V}$ (continued)

At $T_A = +25^\circ\text{C}$, unless otherwise noted.

GLITCH ENERGY: 2.7V, 16LSB STEP, FALLING EDGE

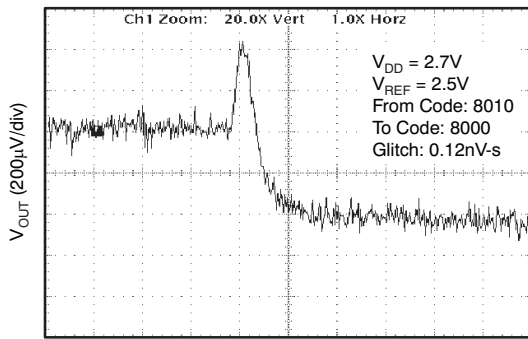

Time (400ns/div)

Figure 42.

GLITCH ENERGY: 2.7V, 256LSB STEP, RISING EDGE

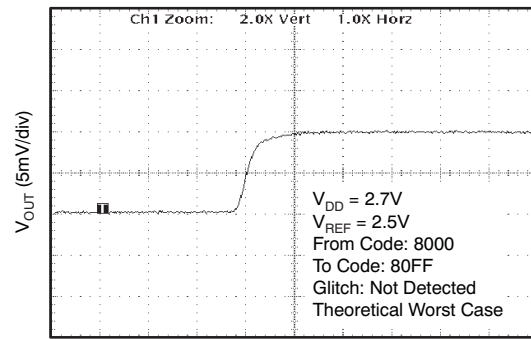

Time (400ns/div)

Figure 43.

GLITCH ENERGY: 2.7V, 256LSB STEP, FALLING EDGE

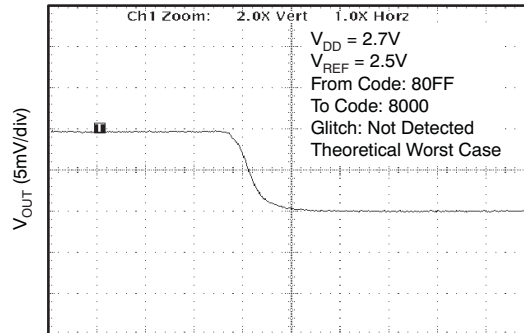

Time (400ns/div)

Figure 44.

THEORY OF OPERATION

DAC SECTION

The architecture of the DAC8850 consists of a string DAC followed by an output buffer amplifier. Figure 45 shows the block diagram of the DAC architecture.

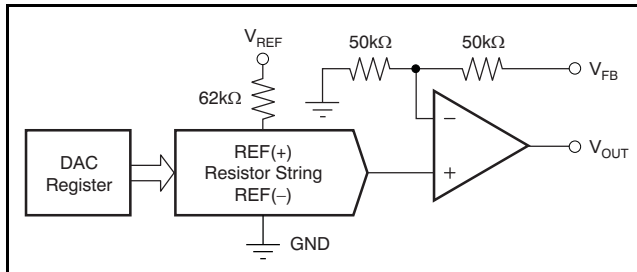

Figure 45. DAC8550 Architecture

The input coding to the DAC8550 is 2's complement, so the ideal output voltage is given by:

$$V_{OUT} = \frac{V_{REF}}{2} + \frac{V_{REF} \times D}{65536} \quad (1)$$

where D = decimal equivalent of the 2's complement code that is loaded to the DAC register; D ranges from -32768 to +32767 where D = 0 is centered at $V_{REF}/2$.

RESISTOR STRING

The resistor string section is shown in Figure 46. It is simply a string of resistors, each of value R. The code loaded into the DAC register determines at which node on the string the voltage is tapped off to be fed into the output amplifier by closing one of the switches connecting the string to the amplifier. Monotonicity is ensured because of the string resistor architecture.

OUTPUT AMPLIFIER

The output buffer amplifier is capable of generating rail-to-rail output voltages with a range of 0V to V_{DD} . It is capable of driving a load of 2kΩ in parallel with 1000pF to GND. The source and sink capabilities of the output amplifier can be seen in the Typical Characteristics. The slew rate is 1.8V/μs with a full-scale setting time of 8μs with the output unloaded.

The inverting input of the output amplifier is brought out to the V_{FB} pin. This architecture allows for better accuracy in critical applications by tying the V_{FB} point and the amplifier output together directly at the load. Other signal conditioning circuitry may also be connected between these points for specific applications.

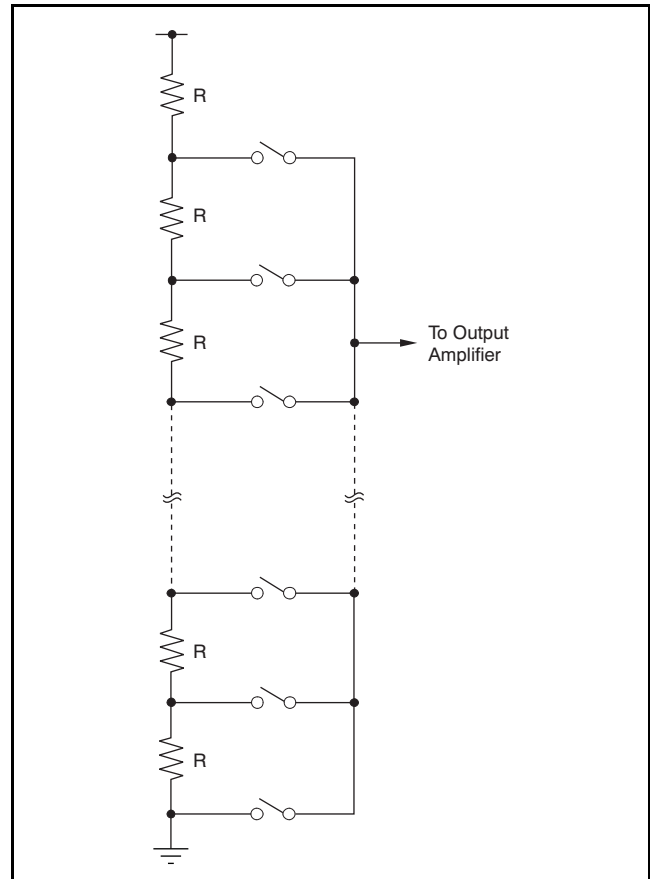

Figure 46. Resistor String

SERIAL INTERFACE

The DAC8550 has a 3-wire serial interface (\overline{SYNC} , SCLK, and D_{IN}), which is compatible with SPI, QSPI, and Microwire interface standards, as well as most DSP interfaces. See the Serial Write Operation timing diagram for an example of a typical write sequence.

The write sequence begins by bringing the \overline{SYNC} line LOW. Data from the D_{IN} line are clocked into the 24-bit shift register on each falling edge of SCLK. The serial clock frequency can be as high as 30MHz, making the DAC8550 compatible with high-speed DSPs. On the 24th falling edge of the serial clock, the last data bit is clocked in and the programmed function is executed (that is, a change in DAC register contents and/or a change in the mode of operation).

At this point, the \overline{SYNC} line may be kept LOW or brought HIGH. In either case, it must be brought HIGH for a minimum of 33ns before the next write sequence so that a falling edge of \overline{SYNC} can initiate the next write sequence. Since the \overline{SYNC} buffer draws more current when the \overline{SYNC} signal is HIGH

than it does when it is LOW, $\overline{\text{SYNC}}$ should be idled LOW between write sequences for lowest power operation of the part. As mentioned above, it must be brought HIGH again just before the next write sequence.

INPUT SHIFT REGISTER

The input shift register is 24 bits wide, as shown in Figure 47. The first six bits are *don't care* bits. The next two bits (PD1 and PD0) are control bits that control which mode of operation the part is in (normal mode or any one of three power-down modes). For a more complete description of the various modes see the *Power-Down Modes* section. The next 16 bits are the data bits. These bits are transferred to the DAC register on the 24th falling edge of SCLK.

SYNC INTERRUPT

In a normal write sequence, the $\overline{\text{SYNC}}$ line is kept LOW for at least 24 falling edges of SCLK and the DAC is updated on the 24th falling edge. However, if $\overline{\text{SYNC}}$ is brought HIGH before the 24th falling edge, it acts as an interrupt to the write sequence. The shift register is reset and the write sequence is seen as invalid. Neither an update of the DAC register contents nor a change in the operating mode occurs, as shown in Figure 48.

POWER-ON RESET

The DAC8550 contains a power-on reset circuit that controls the output voltage during power-up. On power-up, the output voltages are set to midscale; they remain that way until a valid write sequence is made to the DAC. The power-on reset is useful in applications where it is important to know the state of the output of the DAC while it is in the process of powering up.

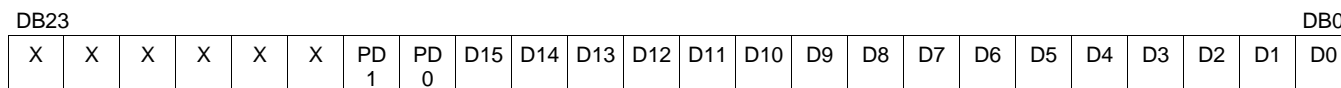

Figure 47. DAC8550 Data Input Register Format

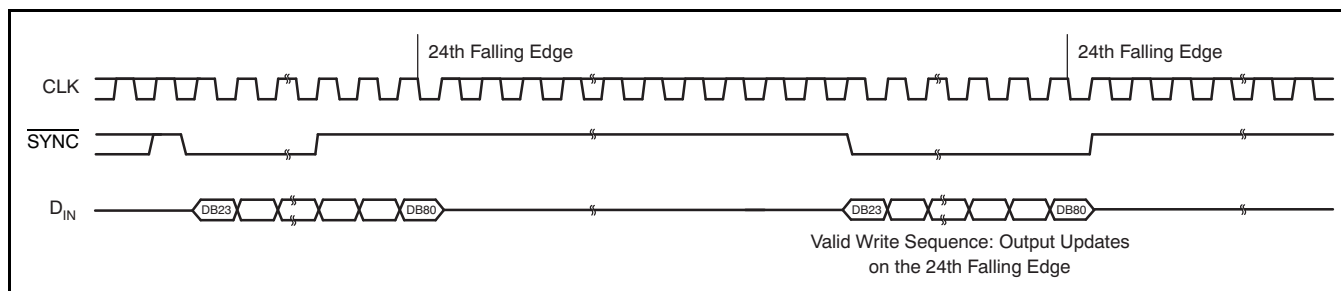

Figure 48. $\overline{\text{SYNC}}$ Interrupt Facility

POWER-DOWN MODES

The DAC8550 supports four separate modes of operation. These modes are programmable by setting two bits (PD1 and PD0) in the control register. [Table 1](#) shows how the state of the bits corresponds to the mode of operation of the device.

Table 1. Operating Modes

PD1 (DB17)	PD0 (DB16)	OPERATING MODE
0	0	Normal operation
—	—	Power-down modes
0	1	Output typically 1kΩ to GND
1	0	Output typically 100kΩ to GND
1	1	High-Z

When both bits are set to '0', the device works normally with a typical current consumption of 200μA at 5V. However, for the three power-down modes, the supply current falls to 200nA at 5V (50nA at 3V). Not only does the supply current fall, but the output stage is also internally switched from the output of the amplifier to a resistor network of known values. The advantage with this configuration is that the output

impedance of the device is known while in power-down mode. There are three different options. The output is connected internally to GND through a 1kΩ resistor, a 100kΩ resistor, or it is left open-circuited (High-Z). The output stage is illustrated in [Figure 49](#).

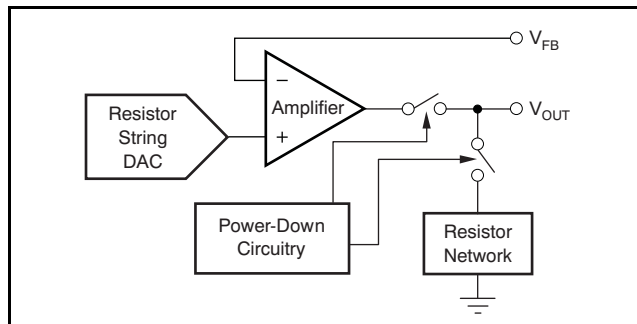

Figure 49. Output Stage During Power-Down

All analog circuitry is shut down when the power-down mode is activated. However, the contents of the DAC register are unaffected when in power-down. The time to exit power-down is typically 2.5μs for $V_{DD} = 5V$, and 5μs for $V_{DD} = 3V$. See the [Typical Characteristics](#) for more information.

MICROPROCESSOR INTERFACING

DAC8550 to 8051 Interface

See [Figure 50](#) for a serial interface between the DAC8550 and a typical 8051-type microcontroller. The setup for the interface is as follows: TXD of the 8051 drives SCLK of the DAC8550, while RXD drives the serial data line of the device. The $\overline{\text{SYNC}}$ signal is derived from a bit-programmable pin on the port of the 8051. In this case, port line P3.3 is used. When data are to be transmitted to the DAC8550, P3.3 is taken LOW. The 8051 transmits data in 8-bit bytes; thus, only eight falling clock edges occur in the transmit cycle. To load data to the DAC, P3.3 is left LOW after the first eight bits are transmitted, then a second write cycle is initiated to transmit the second byte of data. P3.3 is taken HIGH following the completion of the third write cycle. The 8051 outputs the serial data in a format that has the LSB first. The DAC8550 requires its data with the MSB as the first bit received. The 8051 transmit routine must therefore take this into account, and *mirror* the data as needed.

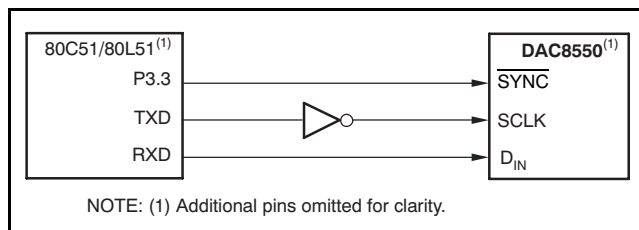

Figure 50. DAC8550 to 80C51/80L51 Interface

DAC8550 to Microwire Interface

[Figure 51](#) shows an interface between the DAC8550 and any Microwire-compatible device. Serial data are shifted out on the falling edge of the serial clock and clocked into the DAC8550 on the rising edge of the SK signal.

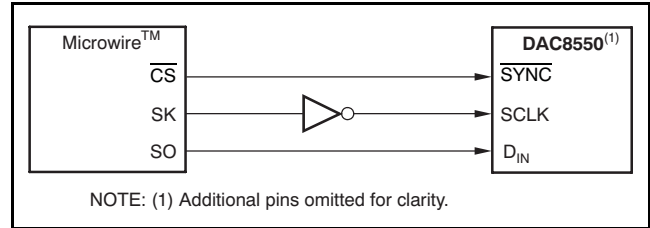

Figure 51. DAC8550 to Microwire Interface

DAC8550 to 68HC11 Interface

[Figure 52](#) shows a serial interface between the DAC8550 and the 68HC11 microcontroller. SCK of the 68HC11 drives the SCLK of the DAC8550, while the MOSI output drives the serial data line of the DAC. The $\overline{\text{SYNC}}$ signal is derived from a port line (PC7), similar to the 8051 diagram.

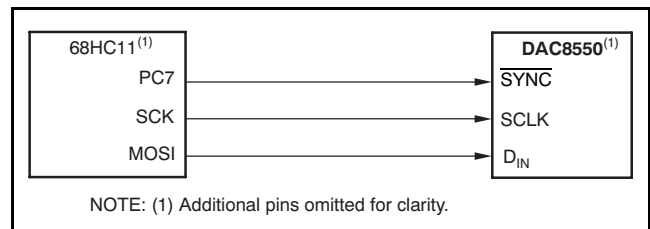

Figure 52. DAC8550 to 68HC11 Interface

The 68HC11 should be configured so that its CPOL bit is '0' and its CPHA bit is '1'. This configuration causes data appearing on the MOSI output to be valid on the falling edge of SCK. When data are being transmitted to the DAC, the $\overline{\text{SYNC}}$ line is held LOW (PC7). Serial data from the 68HC11 are transmitted in 8-bit bytes with only eight falling clock edges occurring in the transmit cycle. (Data are transmitted MSB first.) In order to load data to the DAC8550, PC7 is left LOW after the first eight bits are transferred, then a second and third serial write operation are performed to the DAC. PC7 is taken HIGH at the end of this procedure.

APPLICATION INFORMATION

USING THE REF02 AS A POWER SUPPLY FOR THE DAC8550

Due to the extremely low supply current required by the DAC8550, an alternative option is to use a REF02 +5V precision voltage reference to supply the required voltage to the device, as shown in Figure 53.

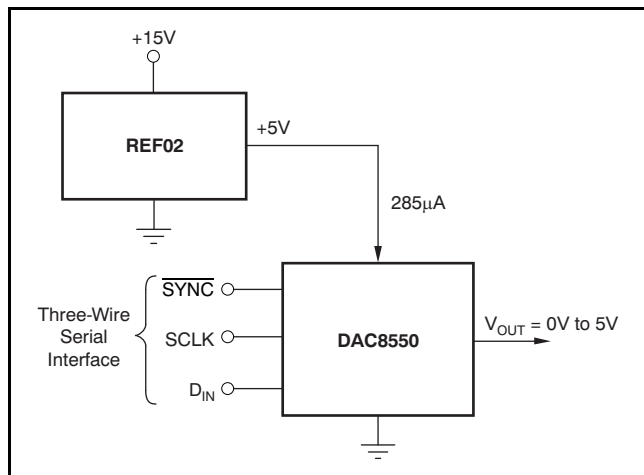

Figure 53. REF02 as a Power Supply to the DAC8550

This configuration is especially useful if the power supply is quite noisy or if the system supply voltages are at some value other than 5V. The REF02 outputs a steady supply voltage for the DAC8550. If the REF02 is used, the current it needs to supply to the DAC8550 is 250µA. This configuration is with no load on the output of the DAC. When a DAC output is loaded, the REF02 also needs to supply the current to the load. The total typical current required (with a 5kΩ load on the DAC output) is:

$$200 \mu\text{A} + \frac{5 \text{ V}}{5 \text{ k}\Omega} = 1.2 \text{ mA} \quad (2)$$

The load regulation of the REF02 is typically 0.005%/mA, resulting in an error of 299µV for the 1.2mA current drawn from it. This value corresponds to an 8.9LSB error.

BIPOLAR OPERATION USING THE DAC8550

The DAC8550 has been designed for single-supply operation, but a bipolar output range is also possible using the circuit in Figure 54. The circuit shown gives an output voltage range of $\pm V_{\text{REF}}$. Rail-to-rail operation at the amplifier output is achievable using an OPA703 as the output amplifier.

The output voltage for any input code can be calculated as follows:

$$V_o = \left[\left(\frac{V_{\text{REF}}}{2} + V_{\text{REF}} \times \frac{D}{65536} \right) \times \left(\frac{R_1 + R_2}{R_1} \right) - V_{\text{REF}} \times \left(\frac{R_2}{R_1} \right) \right] \quad (3)$$

where D represents the input code in 2's complement (–32768 to +32767).

With $V_{\text{REF}} = 5\text{V}$, $R_1 = R_2 = 10\text{k}\Omega$.

$$V_o = 10 \times \frac{D}{65536} \quad (4)$$

Using this example, an output voltage range of $\pm 5\text{V}$ with 8000h corresponding to a –5V output and 8FFFh corresponding to a 5V output can be achieved. Similarly, using $V_{\text{REF}} = 2.5\text{V}$, a $\pm 2.5\text{V}$ output voltage range can be achieved.

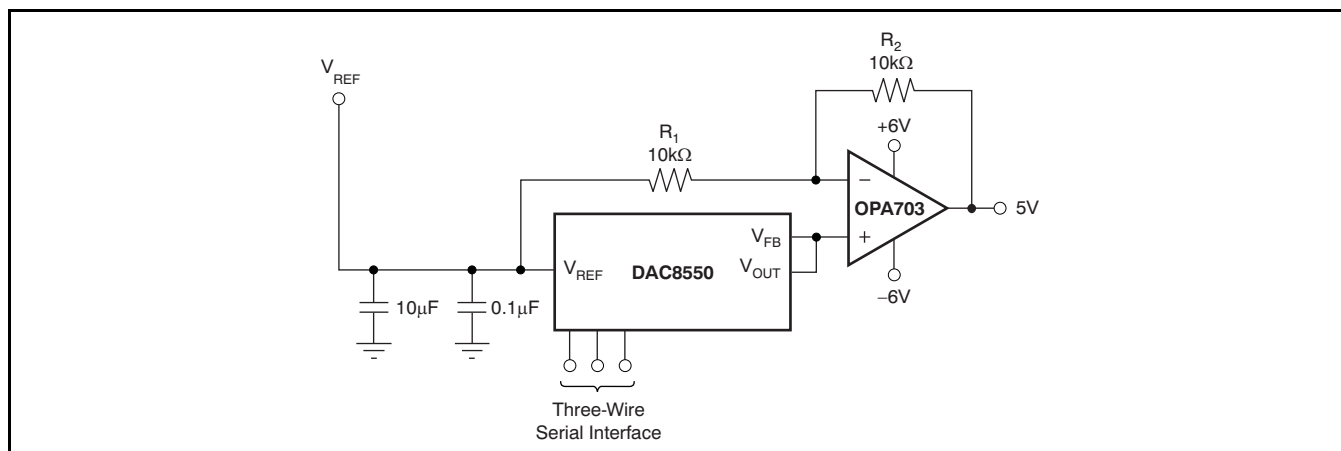

Figure 54. Bipolar Output Range

LAYOUT

A precision analog component requires careful layout, adequate bypassing, and clean, well-regulated power supplies.

The DAC8550 offers single-supply operation and is used often in close proximity with digital logic, microcontrollers, microprocessors, and digital signal processors. The more digital logic present in the design and the higher the switching speed, the more difficult it is to keep digital noise from appearing at the output.

Due to the single ground pin of the DAC8550, all return currents, including digital and analog return currents for the DAC, must flow through a single point. Ideally, GND would be connected directly to an analog ground plane. This plane would be separate from the ground connection for the digital components until they were connected at the power-entry point of the system.

The power applied to V_{DD} should be well-regulated and low-noise. Switching power supplies and dc/dc converters often have high-frequency glitches or spikes riding on the output voltage. In addition, digital components can create similar high-frequency spikes. This noise can easily couple into the DAC output voltage through various paths between the power connections and analog output.

As with the GND connection, V_{DD} should be connected to a 5V power-supply plane or trace that is separate from the connection for digital logic until they are connected at the power-entry point. In addition, a 1 μ F to 10 μ F capacitor and 0.1 μ F bypass capacitor are strongly recommended. In some situations, additional bypassing may be required, such as a 100 μ F electrolytic capacitor or even a *Pi* filter made up of inductors and capacitors, all designed to essentially low-pass filter the 5V supply, removing the high-frequency noise.

REVISION HISTORY

NOTE: Page numbers for previous revisions may differ from page numbers in the current version.

Changes from Revision D (October 2006) to Revision E	Page
• Changed low-level input voltage values in Electrical Characteristics	3
• Changed high-level input voltage values in Electrical Characteristics	3

PACKAGING INFORMATION

Orderable Device	Status (1)	Package Type	Package Drawing	Pins	Package Qty	Eco Plan (2)	Lead/Ball Finish (6)	MSL Peak Temp (3)	Op Temp (°C)	Device Marking (4/5)	Samples
DAC8550IBDGKR	ACTIVE	VSSOP	DGK	8	2500	Green (RoHS & no Sb/Br)	CU NIPDAU CU NIPDAUAG	Level-2-260C-1 YEAR	-40 to 105	D80	Samples
DAC8550IBDGKRG4	ACTIVE	VSSOP	DGK	8	2500	Green (RoHS & no Sb/Br)	CU NIPDAU	Level-2-260C-1 YEAR	-40 to 105	D80	Samples
DAC8550IBDGKT	ACTIVE	VSSOP	DGK	8	250	Green (RoHS & no Sb/Br)	CU NIPDAU CU NIPDAUAG	Level-2-260C-1 YEAR	-40 to 105	D80	Samples
DAC8550IBDGKTG4	ACTIVE	VSSOP	DGK	8	250	Green (RoHS & no Sb/Br)	CU NIPDAU	Level-2-260C-1 YEAR	-40 to 105	D80	Samples
DAC8550IDGKR	ACTIVE	VSSOP	DGK	8	2500	Green (RoHS & no Sb/Br)	CU NIPDAU CU NIPDAUAG	Level-2-260C-1 YEAR	-40 to 105	D80	Samples
DAC8550IDGKRG4	ACTIVE	VSSOP	DGK	8	2500	Green (RoHS & no Sb/Br)	CU NIPDAU	Level-2-260C-1 YEAR	-40 to 105	D80	Samples
DAC8550IDGKT	ACTIVE	VSSOP	DGK	8	250	Green (RoHS & no Sb/Br)	CU NIPDAU CU NIPDAUAG	Level-2-260C-1 YEAR	-40 to 105	D80	Samples
DAC8550IDGKTG4	ACTIVE	VSSOP	DGK	8	250	Green (RoHS & no Sb/Br)	CU NIPDAU	Level-2-260C-1 YEAR	-40 to 105	D80	Samples

(1) The marketing status values are defined as follows:

ACTIVE: Product device recommended for new designs.

LIFEBUY: TI has announced that the device will be discontinued, and a lifetime-buy period is in effect.

NRND: Not recommended for new designs. Device is in production to support existing customers, but TI does not recommend using this part in a new design.

PREVIEW: Device has been announced but is not in production. Samples may or may not be available.

OBSOLETE: TI has discontinued the production of the device.

(2) Eco Plan - The planned eco-friendly classification: Pb-Free (RoHS), Pb-Free (RoHS Exempt), or Green (RoHS & no Sb/Br) - please check <http://www.ti.com/productcontent> for the latest availability information and additional product content details.

TBD: The Pb-Free/Green conversion plan has not been defined.

Pb-Free (RoHS): TI's terms "Lead-Free" or "Pb-Free" mean semiconductor products that are compatible with the current RoHS requirements for all 6 substances, including the requirement that lead not exceed 0.1% by weight in homogeneous materials. Where designed to be soldered at high temperatures, TI Pb-Free products are suitable for use in specified lead-free processes.

Pb-Free (RoHS Exempt): This component has a RoHS exemption for either 1) lead-based flip-chip solder bumps used between the die and package, or 2) lead-based die adhesive used between the die and leadframe. The component is otherwise considered Pb-Free (RoHS compatible) as defined above.

Green (RoHS & no Sb/Br): TI defines "Green" to mean Pb-Free (RoHS compatible), and free of Bromine (Br) and Antimony (Sb) based flame retardants (Br or Sb do not exceed 0.1% by weight in homogeneous material)

(3) MSL, Peak Temp. - The Moisture Sensitivity Level rating according to the JEDEC industry standard classifications, and peak solder temperature.

(4) There may be additional marking, which relates to the logo, the lot trace code information, or the environmental category on the device.

(5) Multiple Device Markings will be inside parentheses. Only one Device Marking contained in parentheses and separated by a "~" will appear on a device. If a line is indented then it is a continuation of the previous line and the two combined represent the entire Device Marking for that device.

(6) Lead/Ball Finish - Orderable Devices may have multiple material finish options. Finish options are separated by a vertical ruled line. Lead/Ball Finish values may wrap to two lines if the finish value exceeds the maximum column width.

Important Information and Disclaimer:The information provided on this page represents TI's knowledge and belief as of the date that it is provided. TI bases its knowledge and belief on information provided by third parties, and makes no representation or warranty as to the accuracy of such information. Efforts are underway to better integrate information from third parties. TI has taken and continues to take reasonable steps to provide representative and accurate information but may not have conducted destructive testing or chemical analysis on incoming materials and chemicals. TI and TI suppliers consider certain information to be proprietary, and thus CAS numbers and other limited information may not be available for release.

In no event shall TI's liability arising out of such information exceed the total purchase price of the TI part(s) at issue in this document sold by TI to Customer on an annual basis.

TAPE AND REEL INFORMATION

QUADRANT ASSIGNMENTS FOR PIN 1 ORIENTATION IN TAPE

*All dimensions are nominal

Device	Package Type	Package Drawing	Pins	SPQ	Reel Diameter (mm)	Reel Width W1 (mm)	A0 (mm)	B0 (mm)	K0 (mm)	P1 (mm)	W (mm)	Pin1 Quadrant
DAC8550IBDGKR	VSSOP	DGK	8	2500	330.0	12.4	5.3	3.4	1.4	8.0	12.0	Q1
DAC8550IBDGKT	VSSOP	DGK	8	250	180.0	12.4	5.3	3.4	1.4	8.0	12.0	Q1
DAC8550IDGKR	VSSOP	DGK	8	2500	330.0	12.4	5.3	3.4	1.4	8.0	12.0	Q1
DAC8550IDGKT	VSSOP	DGK	8	250	180.0	12.4	5.3	3.4	1.4	8.0	12.0	Q1

TAPE AND REEL BOX DIMENSIONS

*All dimensions are nominal

Device	Package Type	Package Drawing	Pins	SPQ	Length (mm)	Width (mm)	Height (mm)
DAC8550IBDGKR	VSSOP	DGK	8	2500	367.0	367.0	35.0
DAC8550IBDGKT	VSSOP	DGK	8	250	210.0	185.0	35.0
DAC8550IDGKR	VSSOP	DGK	8	2500	367.0	367.0	35.0
DAC8550IDGKT	VSSOP	DGK	8	250	210.0	185.0	35.0

DGK (S-PDSO-G8)

PLASTIC SMALL-OUTLINE PACKAGE

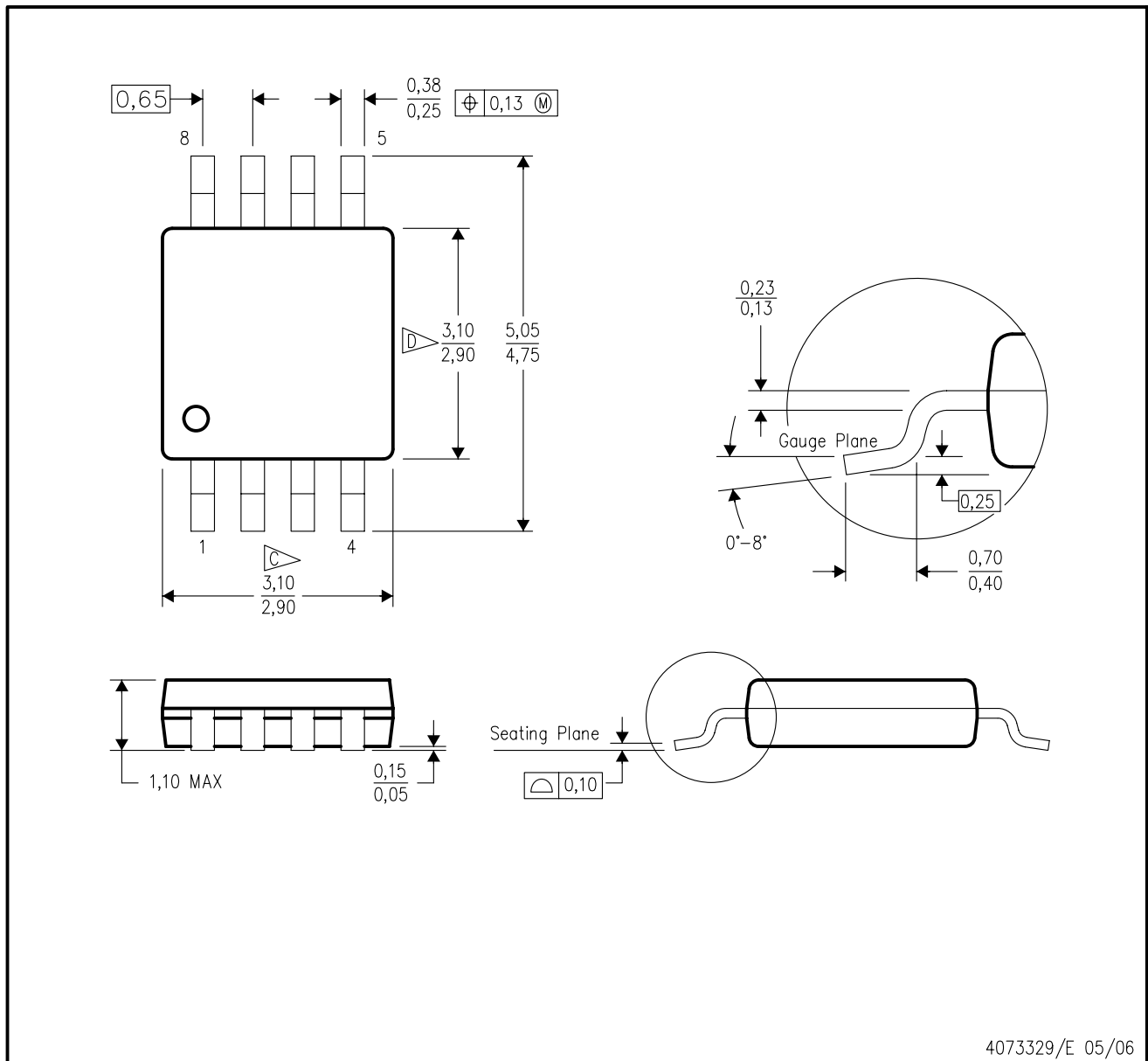

- NOTES:
- A. All linear dimensions are in millimeters.
 - B. This drawing is subject to change without notice.
 - C. Body length does not include mold flash, protrusions, or gate burrs. Mold flash, protrusions, or gate burrs shall not exceed 0.15 per end.
 - D. Body width does not include interlead flash. Interlead flash shall not exceed 0.50 per side.
 - E. Falls within JEDEC MO-187 variation AA, except interlead flash.



- NOTES:
- A. All linear dimensions are in millimeters.
 - B. This drawing is subject to change without notice.
 - C. Publication IPC-7351 is recommended for alternate designs.
 - D. Laser cutting apertures with trapezoidal walls and also rounding corners will offer better paste release. Customers should contact their board assembly site for stencil design recommendations. Refer to IPC-7525 for other stencil recommendations.
 - E. Customers should contact their board fabrication site for solder mask tolerances between and around signal pads.

IMPORTANT NOTICE

Texas Instruments Incorporated and its subsidiaries (TI) reserve the right to make corrections, enhancements, improvements and other changes to its semiconductor products and services per JESD46, latest issue, and to discontinue any product or service per JESD48, latest issue. Buyers should obtain the latest relevant information before placing orders and should verify that such information is current and complete. All semiconductor products (also referred to herein as "components") are sold subject to TI's terms and conditions of sale supplied at the time of order acknowledgment.

TI warrants performance of its components to the specifications applicable at the time of sale, in accordance with the warranty in TI's terms and conditions of sale of semiconductor products. Testing and other quality control techniques are used to the extent TI deems necessary to support this warranty. Except where mandated by applicable law, testing of all parameters of each component is not necessarily performed.

TI assumes no liability for applications assistance or the design of Buyers' products. Buyers are responsible for their products and applications using TI components. To minimize the risks associated with Buyers' products and applications, Buyers should provide adequate design and operating safeguards.

TI does not warrant or represent that any license, either express or implied, is granted under any patent right, copyright, mask work right, or other intellectual property right relating to any combination, machine, or process in which TI components or services are used. Information published by TI regarding third-party products or services does not constitute a license to use such products or services or a warranty or endorsement thereof. Use of such information may require a license from a third party under the patents or other intellectual property of the third party, or a license from TI under the patents or other intellectual property of TI.

Reproduction of significant portions of TI information in TI data books or data sheets is permissible only if reproduction is without alteration and is accompanied by all associated warranties, conditions, limitations, and notices. TI is not responsible or liable for such altered documentation. Information of third parties may be subject to additional restrictions.

Resale of TI components or services with statements different from or beyond the parameters stated by TI for that component or service voids all express and any implied warranties for the associated TI component or service and is an unfair and deceptive business practice. TI is not responsible or liable for any such statements.

Buyer acknowledges and agrees that it is solely responsible for compliance with all legal, regulatory and safety-related requirements concerning its products, and any use of TI components in its applications, notwithstanding any applications-related information or support that may be provided by TI. Buyer represents and agrees that it has all the necessary expertise to create and implement safeguards which anticipate dangerous consequences of failures, monitor failures and their consequences, lessen the likelihood of failures that might cause harm and take appropriate remedial actions. Buyer will fully indemnify TI and its representatives against any damages arising out of the use of any TI components in safety-critical applications.

In some cases, TI components may be promoted specifically to facilitate safety-related applications. With such components, TI's goal is to help enable customers to design and create their own end-product solutions that meet applicable functional safety standards and requirements. Nonetheless, such components are subject to these terms.

No TI components are authorized for use in FDA Class III (or similar life-critical medical equipment) unless authorized officers of the parties have executed a special agreement specifically governing such use.

Only those TI components which TI has specifically designated as military grade or "enhanced plastic" are designed and intended for use in military/aerospace applications or environments. Buyer acknowledges and agrees that any military or aerospace use of TI components which have **not** been so designated is solely at the Buyer's risk, and that Buyer is solely responsible for compliance with all legal and regulatory requirements in connection with such use.

TI has specifically designated certain components as meeting ISO/TS16949 requirements, mainly for automotive use. In any case of use of non-designated products, TI will not be responsible for any failure to meet ISO/TS16949.

Products

Audio	www.ti.com/audio
Amplifiers	amplifier.ti.com
Data Converters	dataconverter.ti.com
DLP® Products	www.dlp.com
DSP	dsp.ti.com
Clocks and Timers	www.ti.com/clocks
Interface	interface.ti.com
Logic	logic.ti.com
Power Mgmt	power.ti.com
Microcontrollers	microcontroller.ti.com
RFID	www.ti-rfid.com
OMAP Applications Processors	www.ti.com/omap
Wireless Connectivity	www.ti.com/wirelessconnectivity

Applications

Automotive and Transportation	www.ti.com/automotive
Communications and Telecom	www.ti.com/communications
Computers and Peripherals	www.ti.com/computers
Consumer Electronics	www.ti.com/consumer-apps
Energy and Lighting	www.ti.com/energy
Industrial	www.ti.com/industrial
Medical	www.ti.com/medical
Security	www.ti.com/security
Space, Avionics and Defense	www.ti.com/space-avionics-defense
Video and Imaging	www.ti.com/video

TI E2E Community

e2e.ti.com